

Bryllupsinvitation

Menu

Førret

Hovedret

Dessert

HANNE

Fin og elegant

bryllupspynt

coop | Kvickly

Du skal bruge:

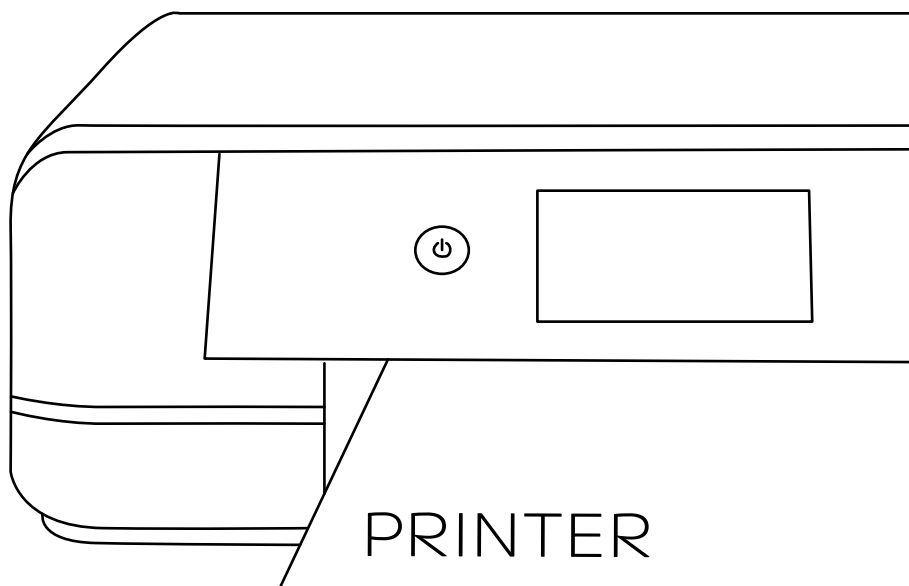
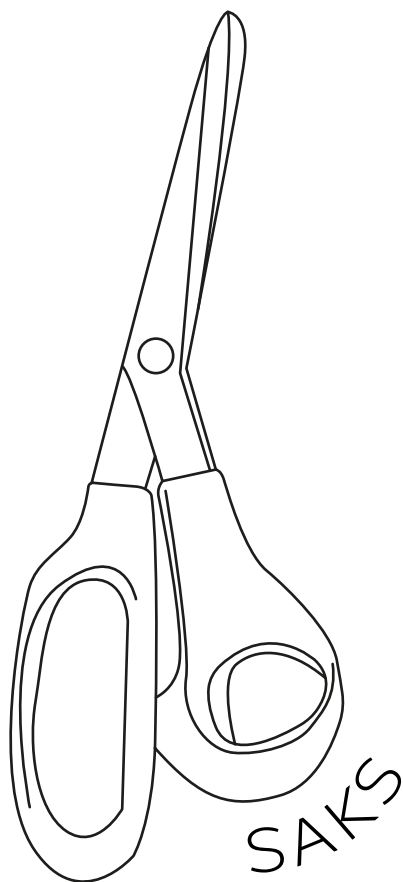

TYKT
PRINTERPAPIR

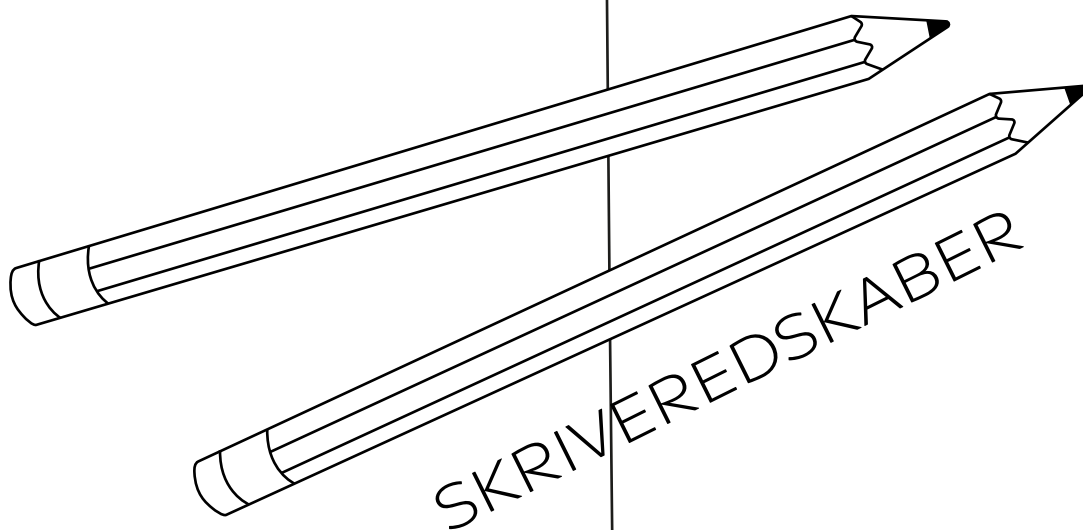

- En saks
- Tykt printerpapir
- Printer med farvepatroner
- Skriveredskaber

Sådan gør du:

Bordkort

Du kan vælge mellem tre typer bordkort på de næste sider. Sommerfuglene og bladene skal lirkes på gafler, mens den sidste variant er det klassiske foldede bordkort, som kan stå selv.

Step 1:

Print de ønskede bordkort ud svarende til antallet af gæster.
Print dem på lidt tykkere papir, så de bliver mere faste.

Step 2:

Klip dem ud.

Step 3:

Skriv gæsternes navne på bordkortene.

Step 4:

Har du valgt sommerfuglen eller bladet, lirkes de forsigtigt ind mellem gafflens tænder, som vist nedenfor.

Har du valgt det klassiske bordkort, foldes det blot på midten.

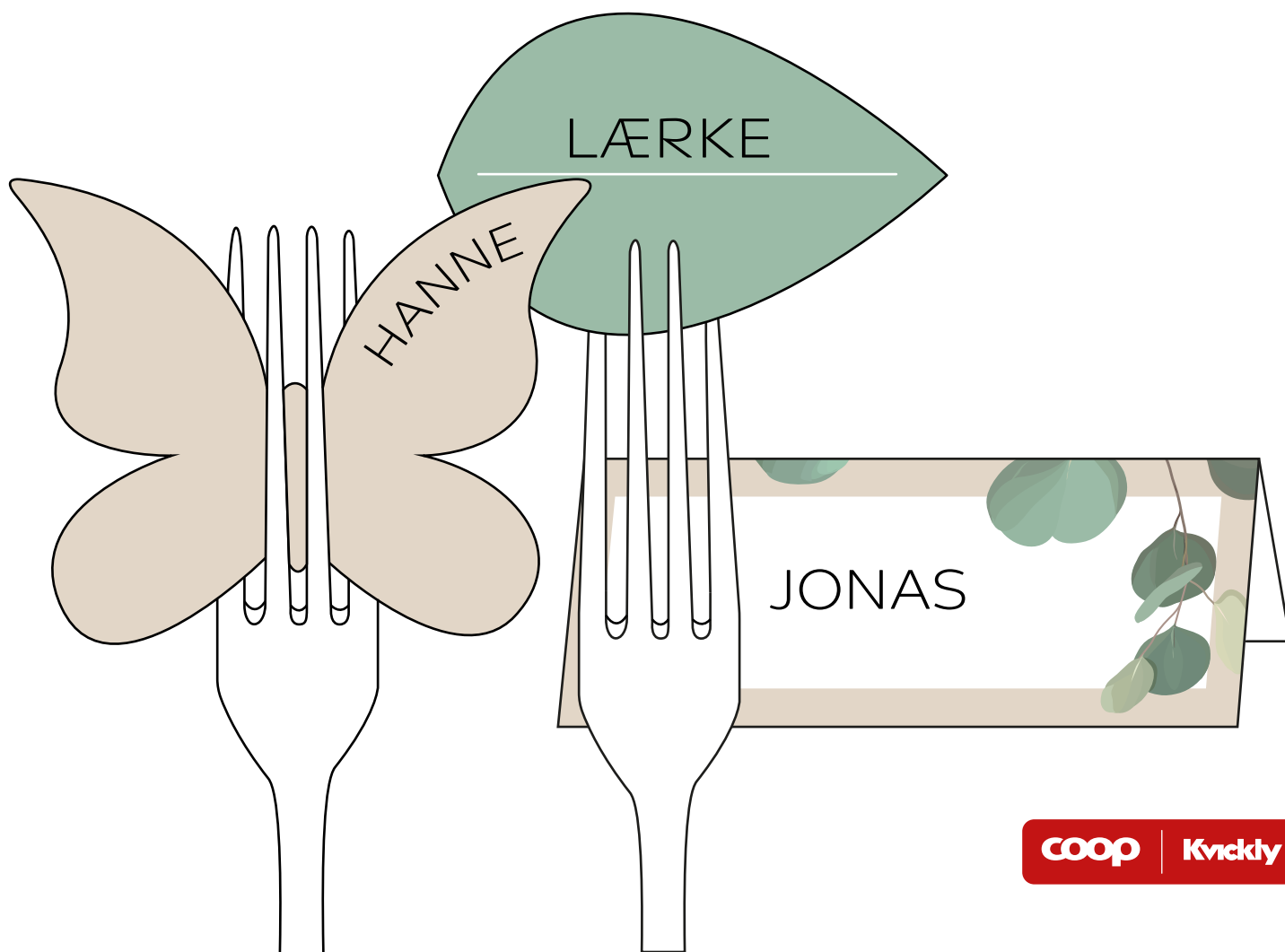

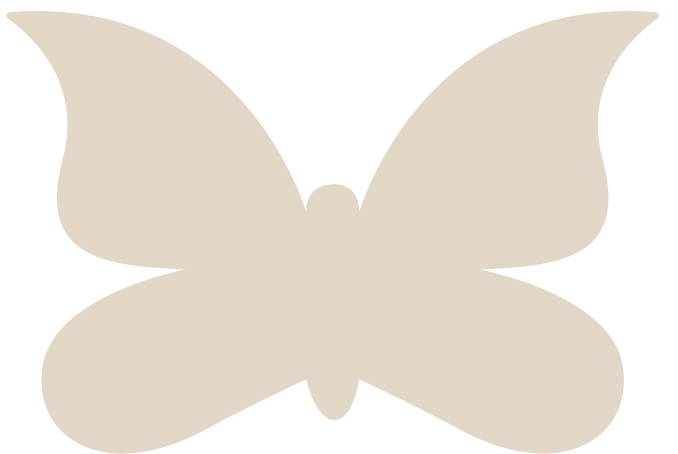
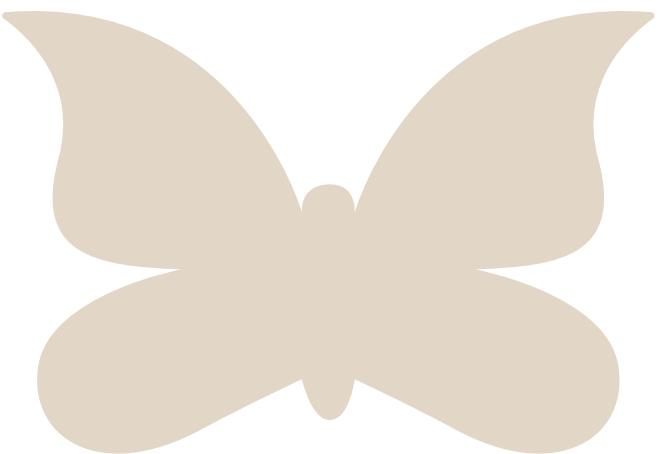
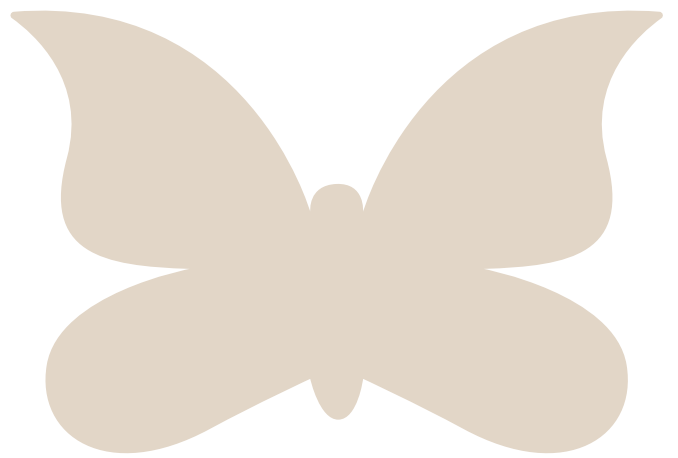
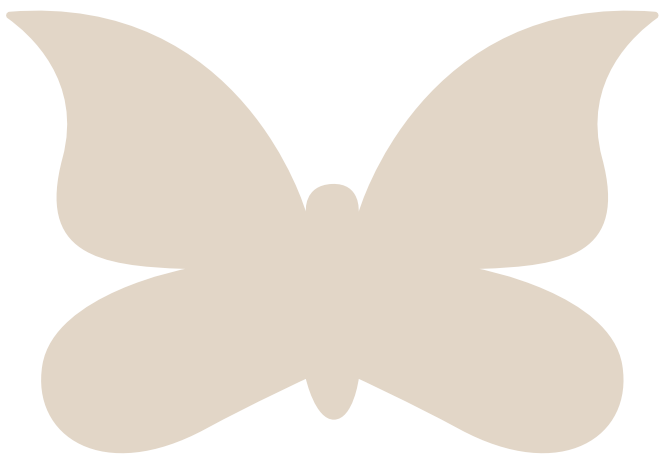
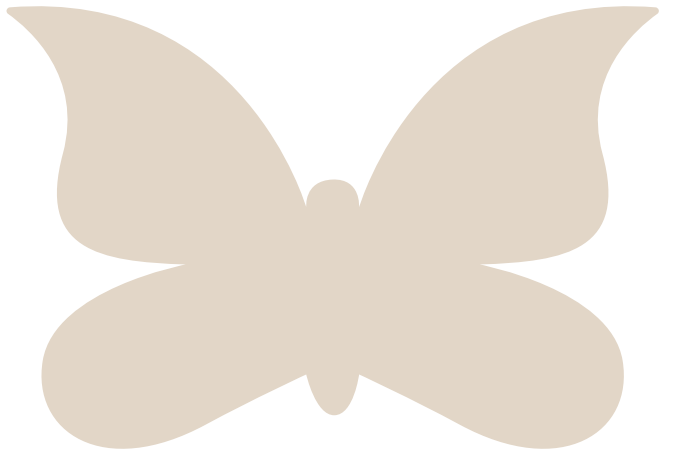
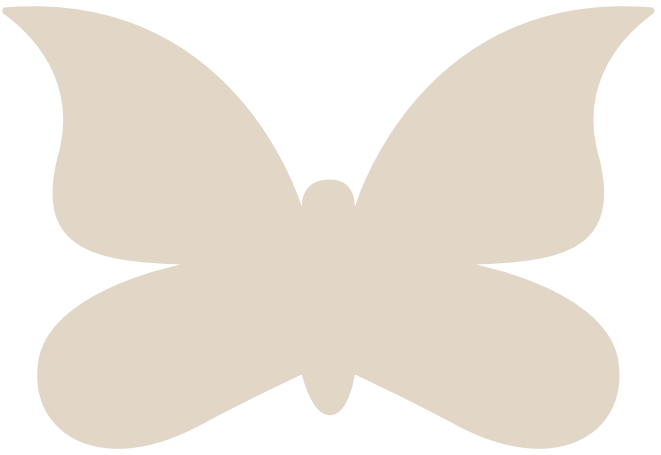
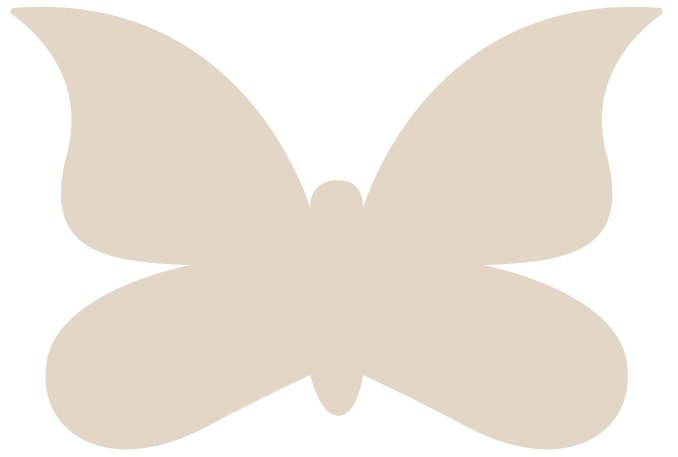
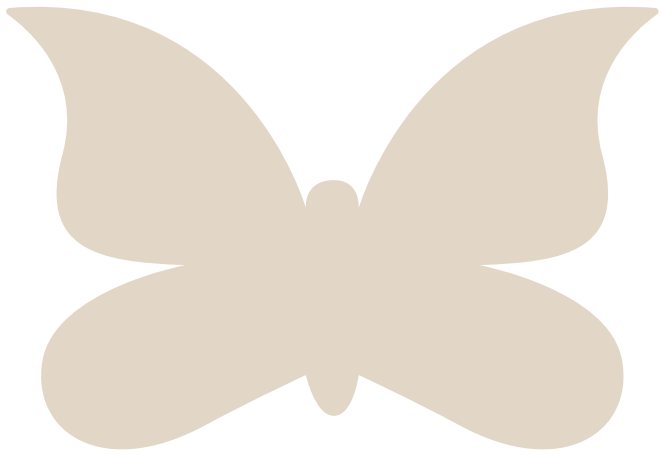

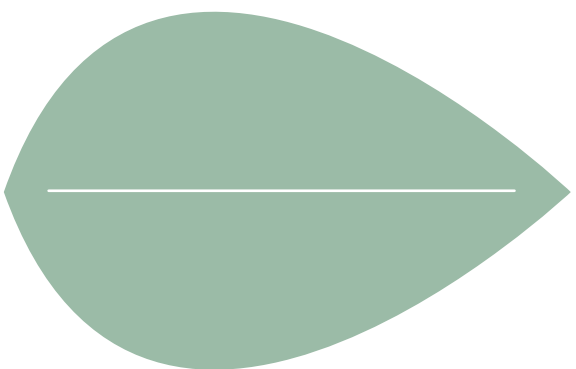
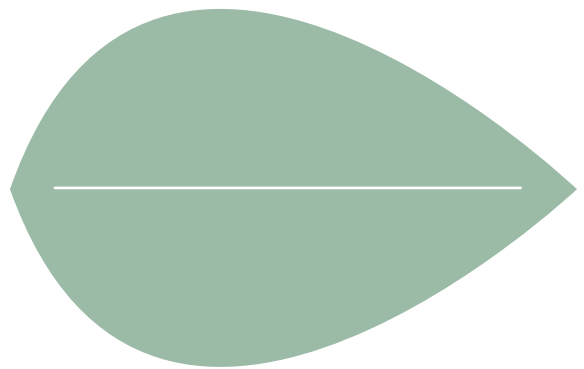
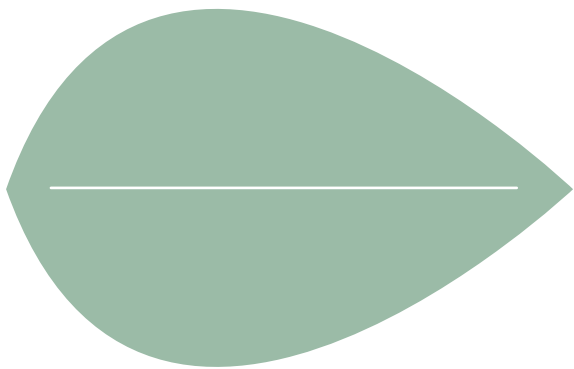
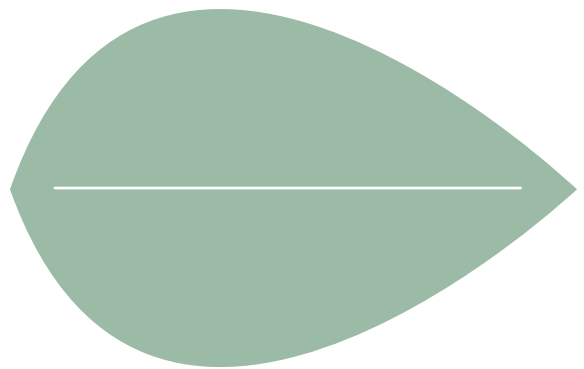
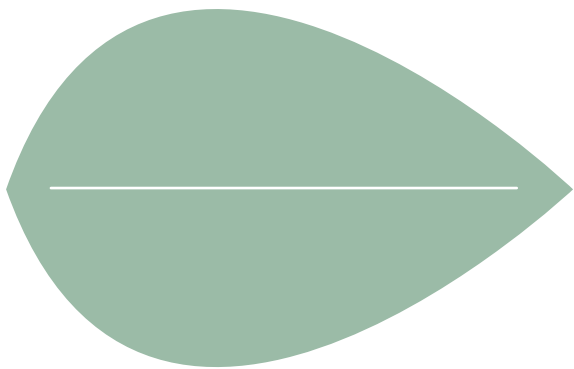
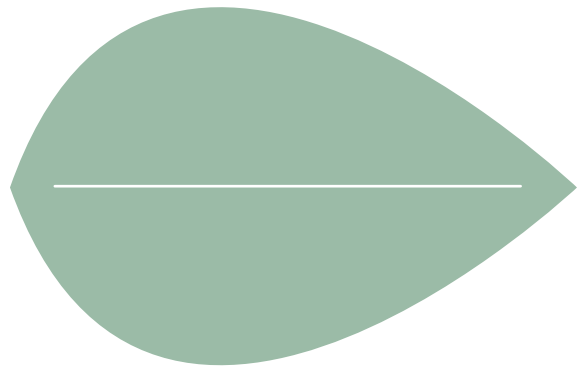
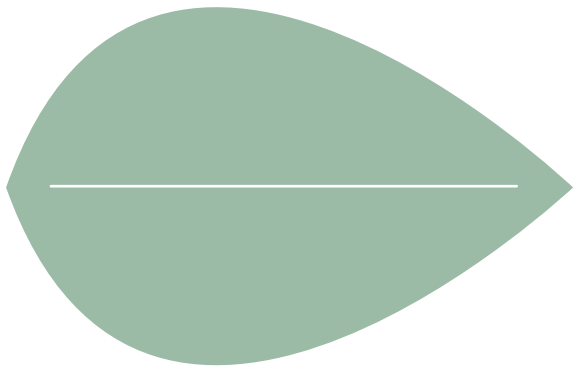
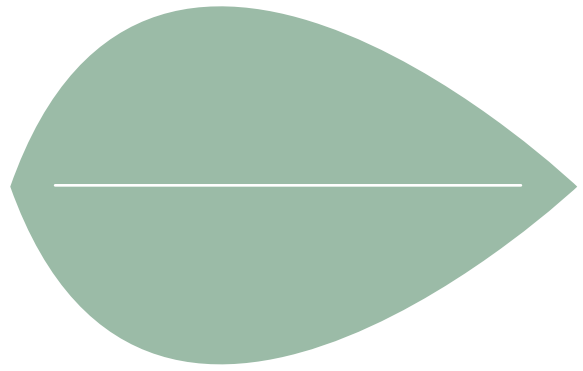

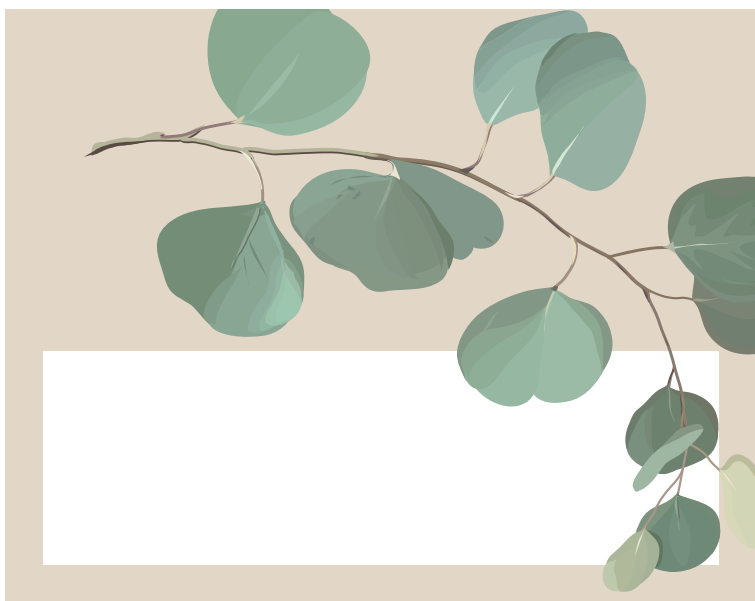
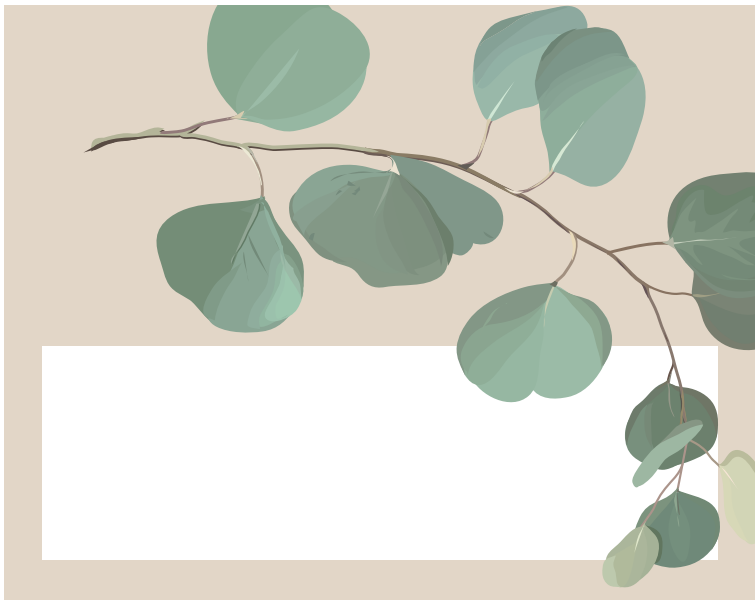
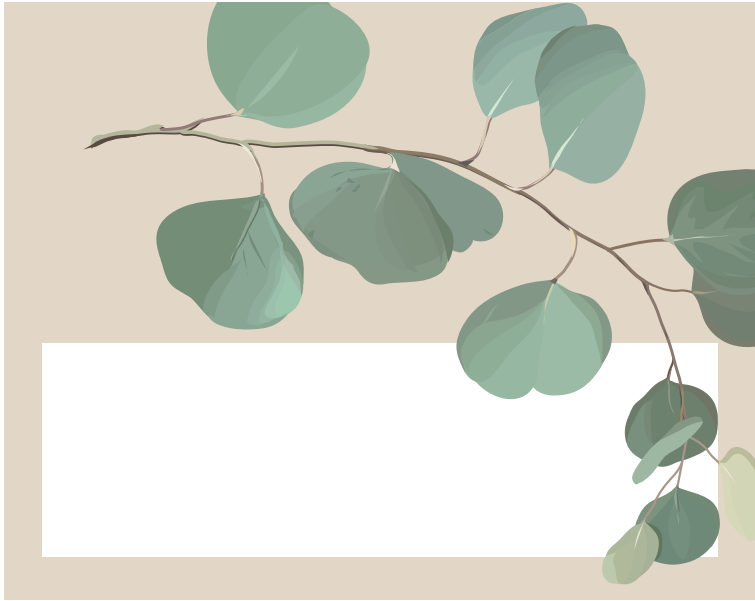

Invitationer:

Før I printer jeres invitationer, er det vigtigt at indstille printeren til at printe dobbeltsidet, således at forsiden og bagsiden af invitationen kommer på samme papir.

Den første invitation er med færdig tekst og den anden er uden, så I selv kan skrive, hvad I ønsker.

Psst... Når I har downloadet pdf'en kan I udfylde invitationen med tekstboks, så I slipper for at skrive alle i hånden.



Kære

I anledningen af vores
BRYLLUP
vil det glæde os at se dig/jer til vielse i
efterfulgt af reception og bryllupsfest i

Vi glæder os meget.
KÆRLIG HILSEN

S.U.



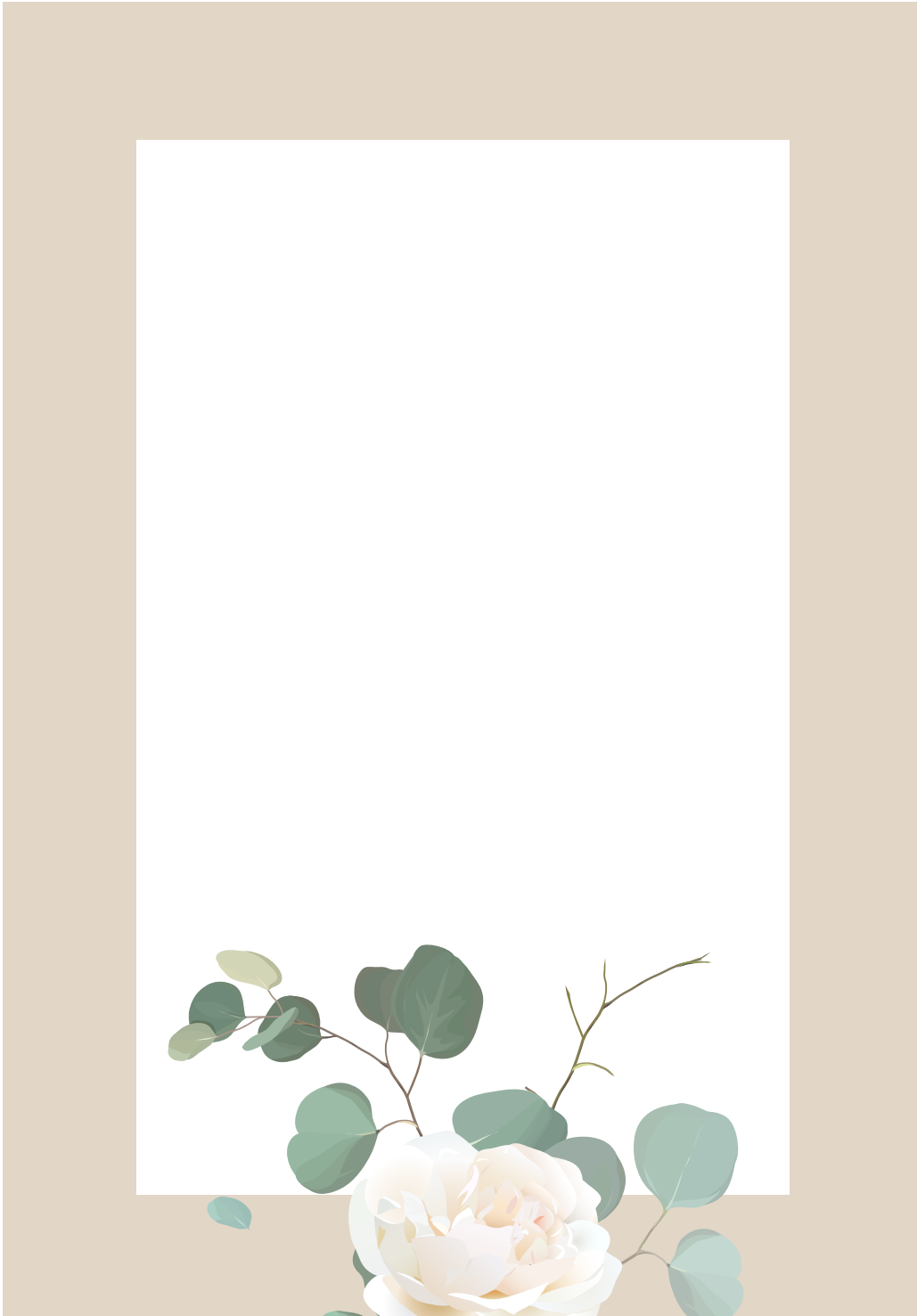



Menukort:

Udfyld menukortet og print så mange eksemplarer I skal bruge.
Print dem på lidt tykkere papir end almindeligt printerpapir.

Psst... Når I har downloadet pdf'en kan I udfylde menukortet med tekstbokse, så I slipper for at skrive alle i hånden.

God fornøjelse og stort tillykke med kærligheden!

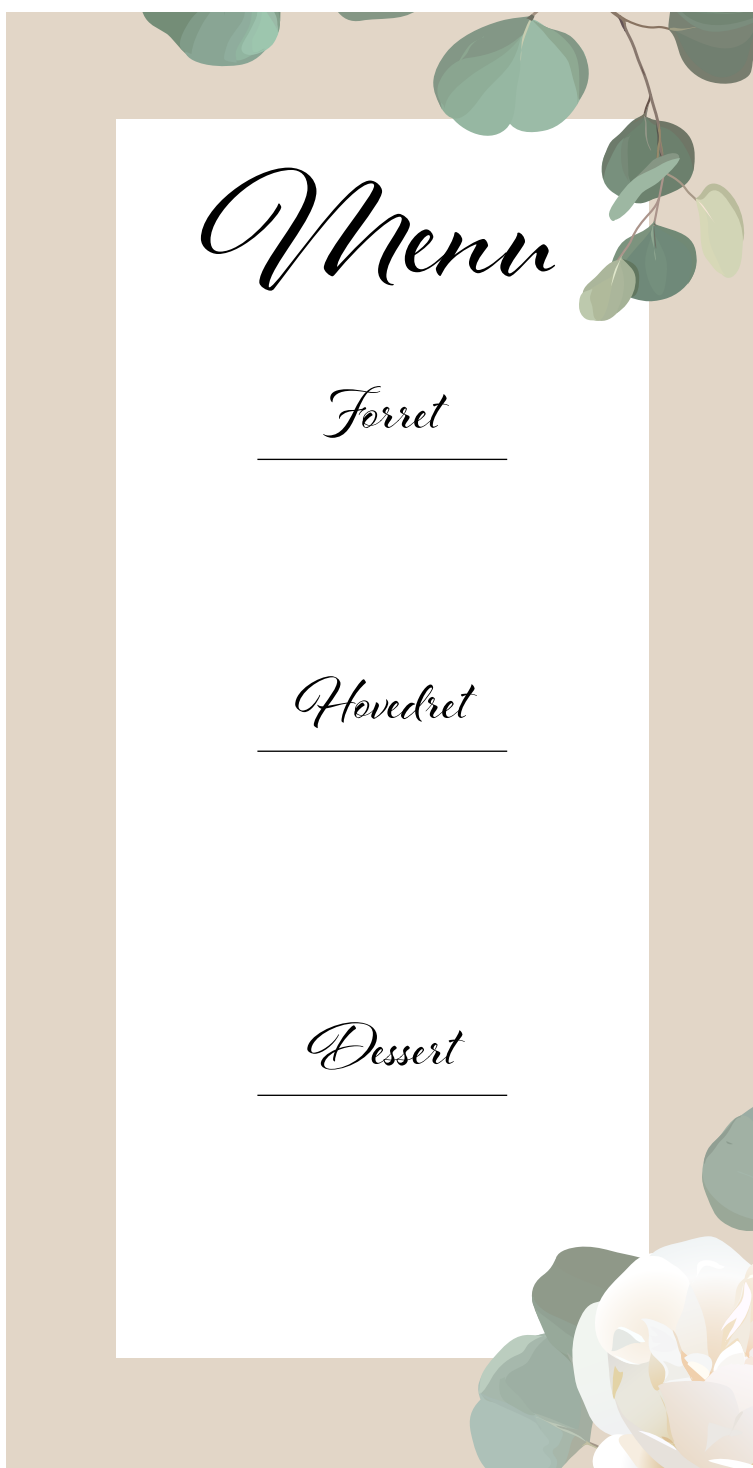



Menu

Forret

Hovedret

Dessert



Menu

Forret

Hovedret

Dessert

